

## Features

- Next Generation Equivalent of ATF20V8B (ATF20V8BQ, ATF22V10BQC)
- Complimentary Easy-to-use Atmel-WinCUPL Design Software
- “Z” Zero Power Compared to “L” Low Power
- Edge-sensing Zero Standby Power (10  $\mu$ A Typical) (CQZ)
- Pin-controlled Zero Standby Power (10  $\mu$ A Typical) Option (C, CQ)
- User-controlled Power-down Pin (C, CQ)
- High-speed Electrically Erasable Programmable Logic Devices
  - 5 ns Maximum Pin-to-pin Delay (C)
- CMOS and TTL Compatible Inputs and Outputs
  - Pin-keeper Feature Holds Inputs and I/Os to Previous Logic States
  - PCI Compliant
- High-reliability EE Process
  - 20 Year Data Retention
  - 100 Erase/Write Cycles
  - 2,000V ESD Protection
  - 200 mA Latch-up Immunity
- Commercial and Industrial Temperature Ranges

## Pin Configurations

All Pinouts Top View

Pin Name	Function
CLK	Clock
IN	Logic Inputs
I/O	Bi-directional Buffers
$\overline{OE}$	Output Enable
NC	No Internal Connection
VCC	+5V Supply
PD	Power-down

TSSOP

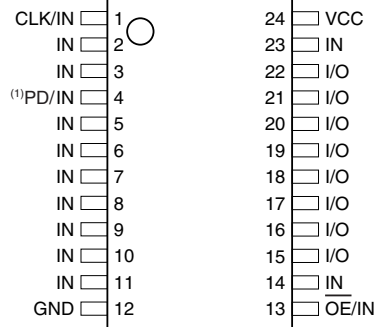

PLCC

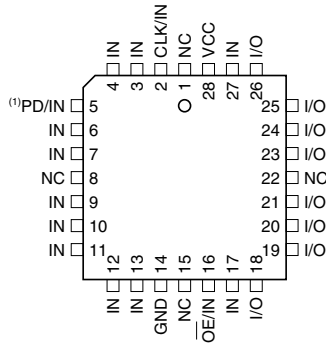

DIP/SOIC

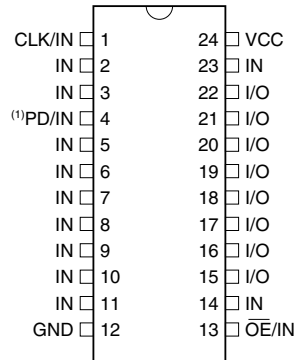

Note: 1. PD on C and CQ only.



**AT20V8C Family**  
**High-**  
**performance**  
**EE PLD**

**ATF20V8C**  
**ATF20V8CQ**  
**ATF20V8CQZ**



## Block Diagram

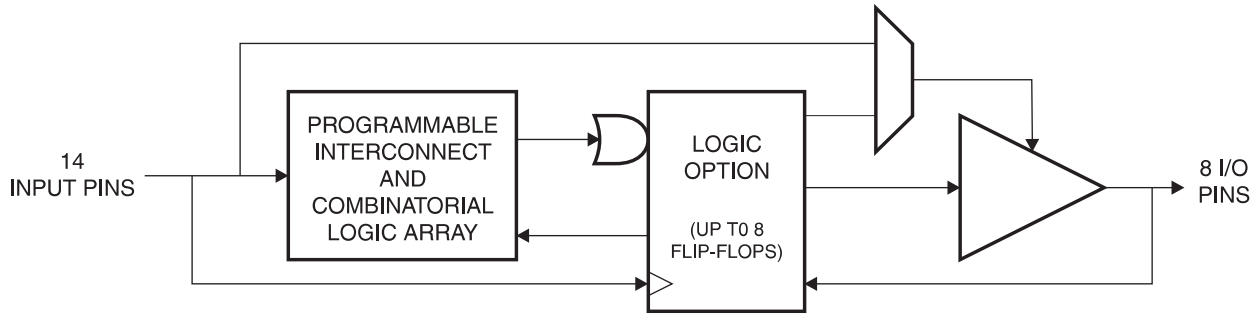

## Description

The ATF20V8C is a high-performance CMOS (electrically erasable) programmable logic device (PLD) that utilizes Atmel's proven electrically erasable technology. Speeds down to 5 ns and power dissipation as low as 10  $\mu$ A are offered. All speed ranges are specified over the full 5V  $\pm$  10% range for industrial temperature ranges, and 5V  $\pm$  5% for commercial ranges.

The ATF20V8C(Q) provides a high-speed CMOS PLD solution with maximum pin-to-pin delay of 5 ns. The ATF20V8C(Q) also has a user-controlled power-down feature, offering "zero" standby power (10  $\mu$ A typical). The user-controlled power-down feature allows the user to manage total system power to meet specific application requirements and enhance reliability without sacrificing speed.

The ATF20V8CQZ provides the zero power CMOS PLD solution, with "zero" standby power (10  $\mu$ A typical). The device powers down automatically through Atmel's patented Input Transition Detection (ITD) circuitry to the "zero" standby power mode when all inputs are idle.

Pin "keeper" circuits on input and output pins reduce static power consumed by pull-ups.

The ATF20V8C(Q)(Z) is the industry-standard 20V8 architecture. Eight outputs are each allocated eight product terms. Three different modes of operation, configured automatically with software, allow highly complex logic functions to be realized.

### Power-up Reset

The registers in the ATF20V8Cs are designed to reset during power-up. At a point delayed slightly from  $V_{CC}$  crossing  $V_{RST}$ , all registers will be reset to the low state. As a result, the registered output state will always be high on power-up.

This feature is critical for state machine initialization. However, due to the asynchronous nature of reset and the

uncertainty of how  $V_{CC}$  actually rises in the system, the following conditions are required:

1. The  $V_{CC}$  rise must be monotonic,
2. After reset occurs, all input and feedback setup times must be met before driving the clock pin high, and
3. The clock must remain stable during  $t_{PR}$ .

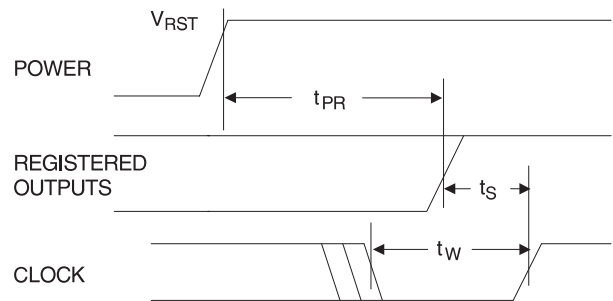

### Preload of Registered Outputs

The ATF20V8C registers are provided with circuitry to allow loading of each register with either a high or a low. This feature will simplify testing since any state can be forced into the registers to control test sequencing. A JEDEC file with preload is generated when a source file with vectors is compiled. Once downloaded, the JEDEC file preload sequence will be done automatically by most of the approved programmers after the programming.

### Electronic Signature Word

There are 64 bits of programmable memory that are always available to the user, even if the device is secured. These bits can be used for user-specific data.

## Security Fuse Usage

A single fuse is provided to prevent unauthorized copying of the ATF20V8C's fuse patterns. Once programmed, fuse verify and preload are inhibited. However, the 64-bit User Signature remains accessible.

The security fuse should be programmed last, as its effect is immediate.

## Programming/Erasing

Programming/erasing is performed using standard PLD programmers. For further information, see the Configurable

Logic data book section titled, "CMOS PLD Programming Hardware and Software Support."

## Input and I/O Pull-ups

All ATF20V8C family members have internal input and I/O "pin-keeper" circuits. Therefore, whenever inputs or I/Os are not being driven externally, they will maintain their last driven state. This ensures that all logic array inputs and device outputs are at known states. These are relatively weak active circuits that can be easily overridden by TTL-compatible drivers (see input and I/O diagrams below).

## Input Diagram

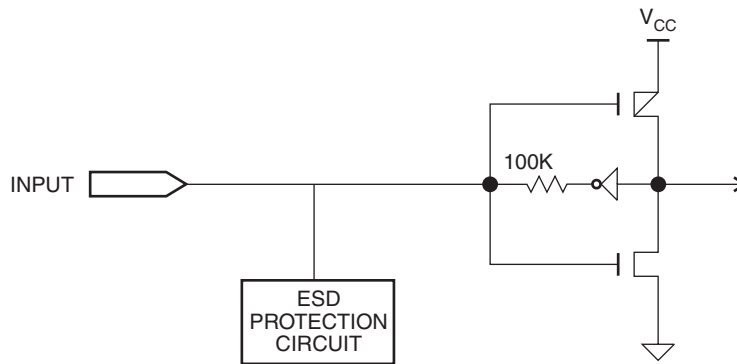

## I/O Diagram

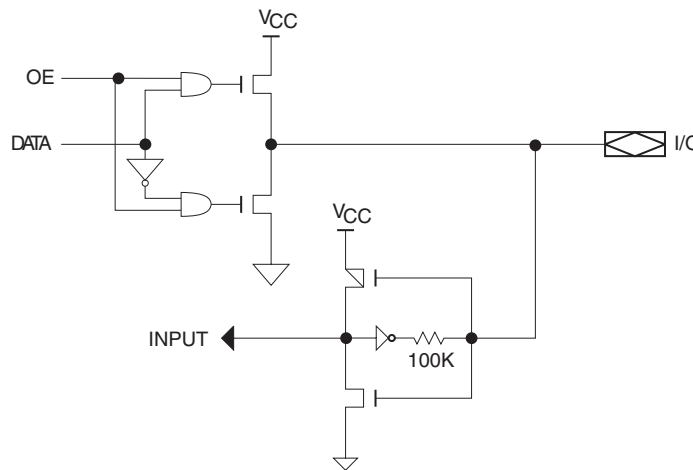



## Functional Logic Diagram Description

The logic option and functional diagrams describe the ATF20V8C architecture. Eight configurable macrocells can be configured as a registered output, combinatorial I/O, combinatorial output or dedicated input.

The ATF20V8C's macrocell can be configured in one of three different modes. Each mode makes the ATF20V8Cs look like a different device. The ATF20V8Cs can be a registered output, combinatorial I/O, combinatorial output or dedicated input. Most PLD compilers can choose the right mode automatically. The user can also force the selection by supplying the compiler with a mode selection. The determining factors would be the usage of register versus combinatorial outputs and dedicated outputs versus output with output enable control.

The ATF20V8Cs have a user-controlled power-down pin, which, when active, allows the user to place the device into a "zero" standby power-down mode. The device can also

operate at high speed. Maximum pin-to-pin delays of 5 ns are offered. Static power loss due to pull-up resistors is eliminated by using input and output pin "keeper" circuits that hold pins to their previous logic levels when idle.

The universal architecture of the ATF20V8Cs can be programmed to emulate many 24-pin PAL devices. The user can download the subset device JEDEC programming file to the PLD programmer and the ATF20V8Cs can be configured to act like the chosen device.

Unused product terms are automatically disabled by the compiler to decrease power consumption. A security fuse, when programmed, protects the contents the ATF20V8Cs. Eight bytes (64 fuses) of User Signature are accessible to the user for purposes such as storing project name, part number, revision or date. The User Signature is accessible regardless of the state of the security fuse.

## Compiler Mode Selection

	Registered	Complex	Simple	Auto Select
<b>ABEL, Atmel-ABEL</b>	P20V8R	P20V8C	P20V8	P20V8
<b>CUPL</b>	G20V8MS	G20V8MA	G20V8	G20V8A
<b>LOG/iC</b>	GAL20V8_R <sup>(1)</sup>	GAL20V8_C7 <sup>(1)</sup>	GAL20V8_C8 <sup>(1)</sup>	GAL20V8
<b>OrCAD-PLD</b>	"Registered"	"Complex"	"Simple"	GAL20V8
<b>PLDesigner</b>	P20V8	P20V8	P20V8	P20V8
<b>Tango-PLD</b>	G20V8	G20V8	G20V8	G20V8

Note: 1. Only applicable for version 3.4 or lower.

## Registered Mode

### PAL Device Emulation/PAL Replacement

The registered mode is used if one or more registers are required. Each macrocell can be configured as either a registered or combinatorial output or I/O, or as an input. For a registered output or I/O, the output is enabled by the  $\overline{OE}$  pin, and the register is clocked by the CLK pin. Eight product terms are allocated to the sum term. For a combinatorial output or I/O, the output enable is controlled by a product term, and seven product terms are allocated to the

sum term. When the macrocell is configured as an input, the output enable is permanently disabled.

Any register usage will make the compiler select this mode. The following registered devices can be emulated using this mode:

20R8	20RP8
20R6	20RP6
20R4	20RP4

### Registered Mode Operation

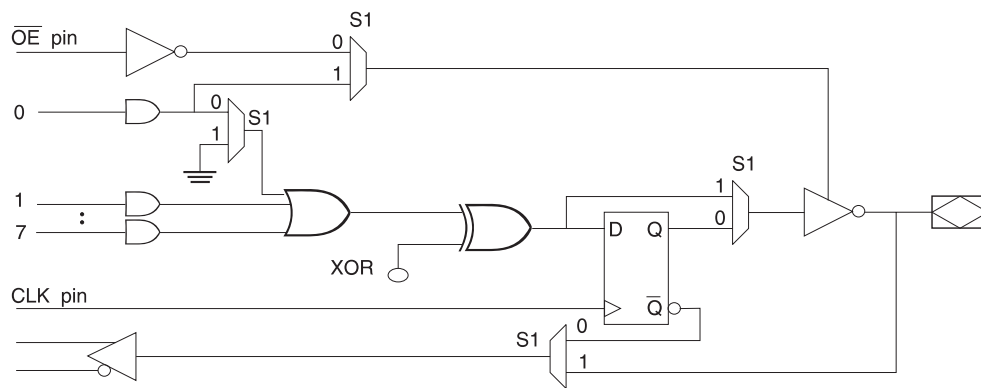

# Registered Mode Logic Diagram

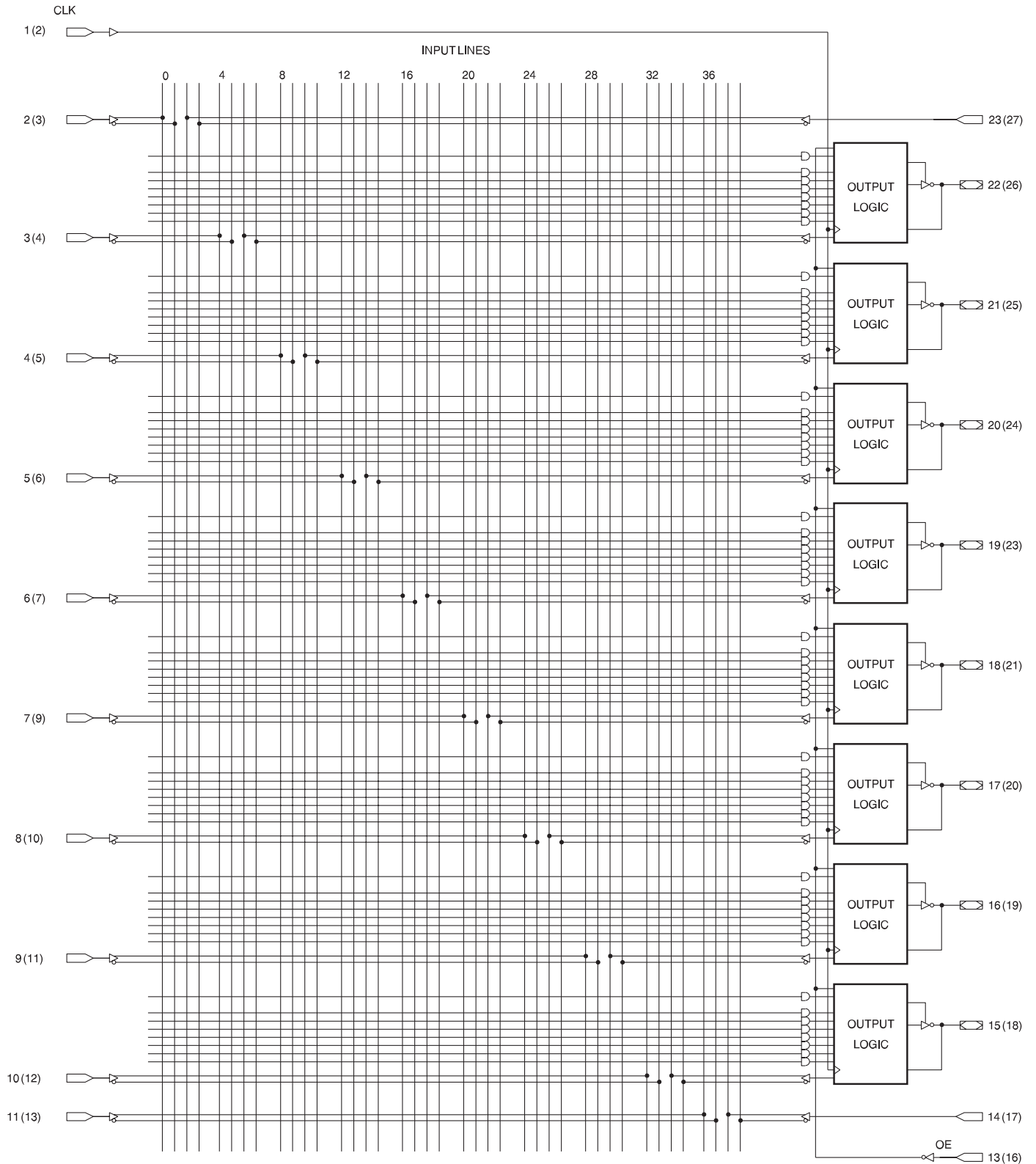

## Complex Mode

### PAL Device Emulation/PAL Replacement

In the Complex Mode, combinatorial output and I/O functions are possible. Pins 1 and 11 are regular inputs to the array. Pins 13 through 18 have pin feedback paths back to the AND-array, which makes full I/O capability possible. Pins 12 and 19 (outermost macrocells) are outputs only. They do not have input capability. In this mode, each macrocell has seven product terms going to the sum term and one product term enabling the output.

Combinatorial applications with an OE requirement will make the compiler select this mode. The following devices can be emulated using this mode:

- 20L8
- 20H8
- 20P8

### Complex Mode Operation

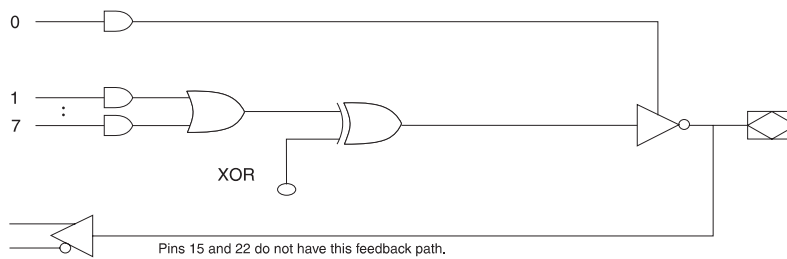

## Simple Mode

### PAL Device Emulation/PAL Replacement

In the Simple Mode, eight product terms are allocated to the sum term. Pins 15 and 16 (center macrocells) are permanently configured as combinatorial outputs. Other macrocells can be either inputs or combinatorial outputs with pin feedback to the AND-array. Pins 1 and 11 are regular inputs.

The compiler selects this mode when all outputs are combinatorial without OE control. The following simple PALs can be emulated using this mode:

- |      |      |      |
|------|------|------|
| 14L8 | 14H8 | 14P8 |
| 16L6 | 18H6 | 16P6 |
| 18L4 | 18H4 | 18P4 |
| 20L2 | 20H2 | 20P2 |

### Simple Mode Option

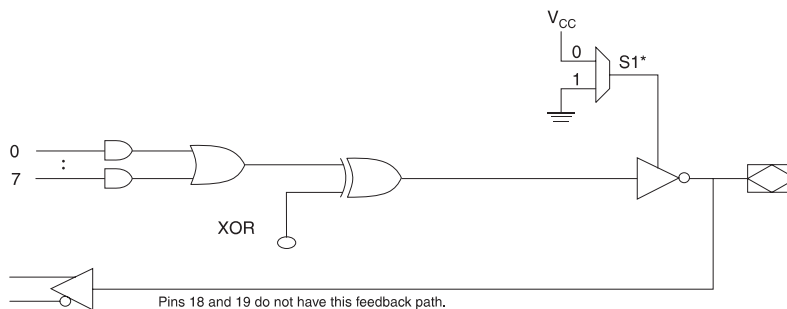

\* - Pins 18 and 19 are always enabled.

# Complex Mode Logic Diagram

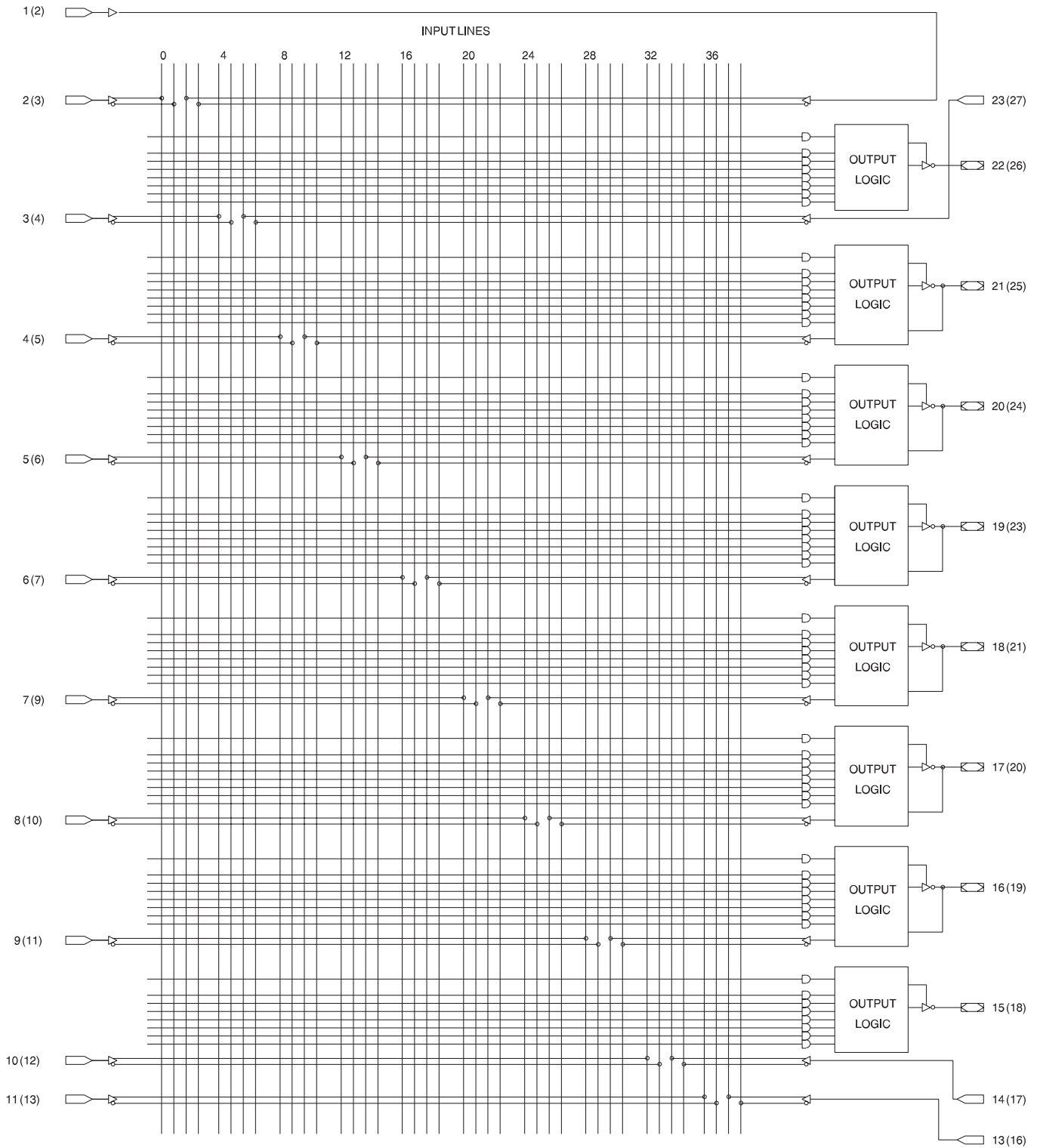



## Simple Mode Logic Diagram

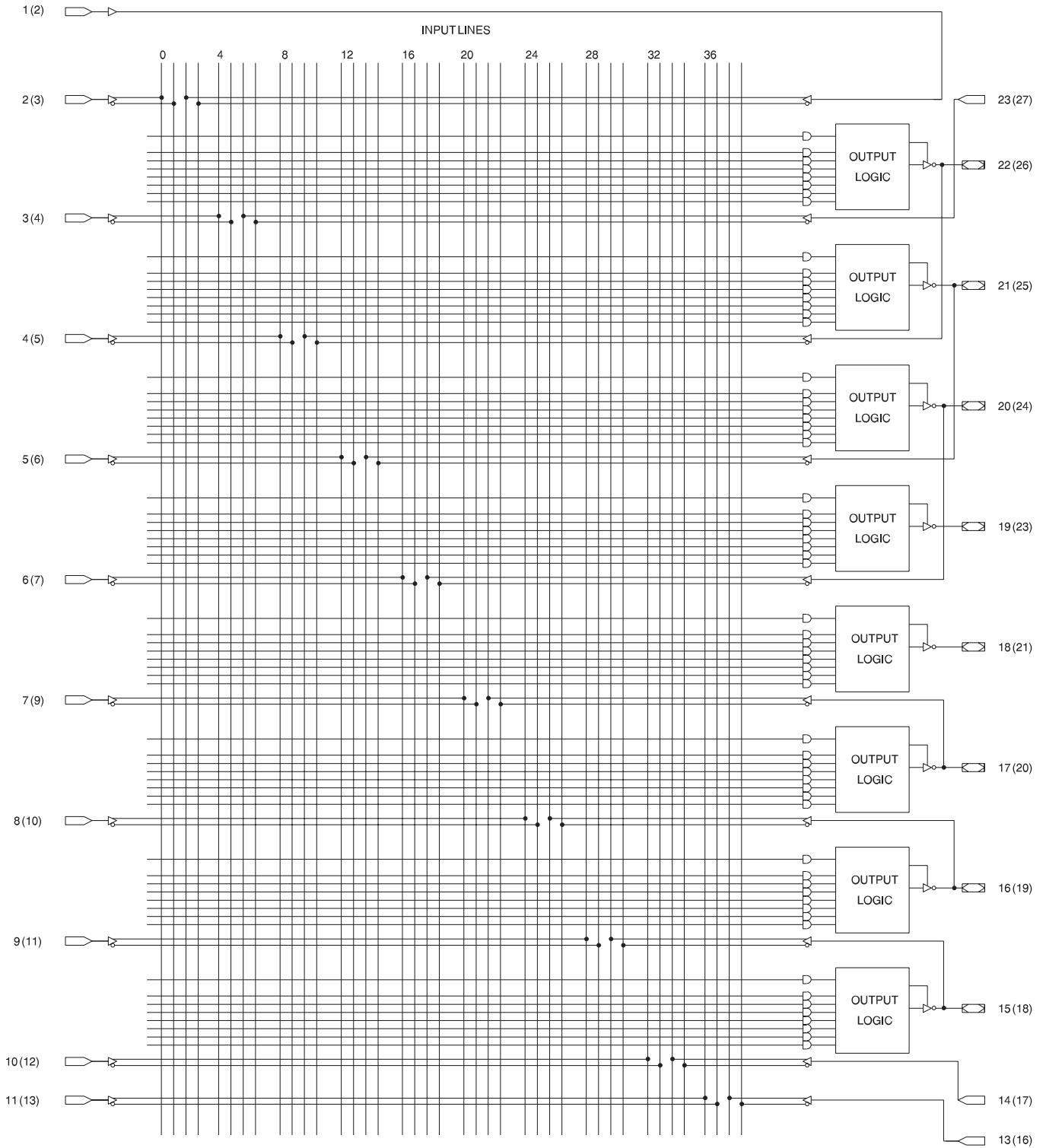



## Absolute Maximum Ratings\*

Temperature under Bias .....	-55°C to +125°C
Storage Temperature .....	-65°C to +150°C
Voltage on Any Pin with Respect to Ground .....	-2.0V to +7.0V <sup>(1)</sup>
Voltage on Input Pins with Respect to Ground during Programming .....	-2.0V to +14.0V <sup>(1)</sup>
Programming Voltage with Respect to Ground .....	-2.0V to +14.0V <sup>(1)</sup>

\*NOTICE: Stresses beyond those listed under “Absolute Maximum Ratings” may cause permanent damage to the device. This is a stress rating only and functional operation of the device at these or any other conditions beyond those indicated in the operational sections of this specification is not implied. Exposure to absolute maximum rating conditions for extended periods may affect device reliability.

Note: 1. Minimum voltage is -0.6V DC, which may undershoot to -2.0V for pulses of less than 20 ns. Maximum output pin voltage is  $V_{CC} + 0.75V$  DC, which may overshoot to 7.0V for pulses of less than 20 ns.

## DC and AC Operating Conditions

	Commercial	Industrial
Operating Temperature (Ambient)	0°C - 70°C	-40°C - 85°C
$V_{CC}$ Power Supply	5V ± 5%	5V ± 10%

Parameter	Description	Typ	Max	Units
$t_{PR}$	Power-up Reset Time	600	1,000	ns
$V_{RST}$	Power-up Reset Voltage	3.8	4.5	V

## Input Test Waveforms and Measurement Levels

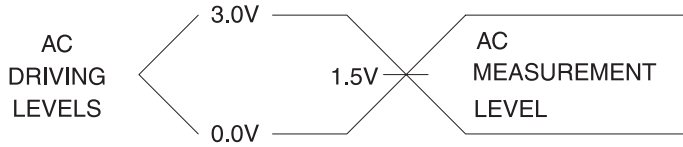

$t_R, t_F < 1.5 \text{ ns}$  (10% to 90%)

## Output Test Loads

Commercial

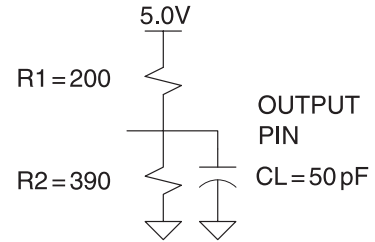

## Pin Capacitance

$f = 1 \text{ MHz}$ ,  $T = 25^\circ\text{C}^{(1)}$

	Typ	Max	Units	Conditions
$C_{IN}$	5	8	pF	$V_{IN} = 0V$
$C_{OUT}$	6	8	pF	$V_{OUT} = 0V$

Note: 1. Typical values for nominal supply voltage. This parameter is only sampled and is not 100% tested.



## ATF20V8C DC Characteristics

$V_{CC} = 5.0V$  and  $T_A = 25^\circ C$

Symbol	Parameter	Condition	Min	Typ	Max	Units	
$I_{IL}$	Input or I/O Low Leakage Current	$0 \leq V_{IN} \leq V_{IL} \text{ (Max)}$		-35	-100	$\mu A$	
$I_{IH}$	Input or I/O High Leakage Current	$3.5 \leq V_{IN} \leq V_{CC}$			10	$\mu A$	
$I_{CC}$	Power Supply Current, Standby	$V_{CC} = \text{Max},$ $V_{IN} = \text{Max},$ Outputs Open	C-5	Com.	60	90	mA
			C-5	Ind.	60	100	mA
			C-7	Com.	60	90	mA
			C-7	Ind.	60	100	mA
			C-10	Com.	60	80	mA
			C-10	Ind.	60	90	mA
			C-15	Com.	60	80	mA
			C-15	Ind.	60	90	mA
$I_{CC2}$	Clocked Power Supply Current	$V_{CC} = \text{Max},$ Outputs Open, $f = 15 \text{ MHz}$	C-5	Com.	70	110	mA
			C-5	Ind.	70	125	mA
			C-7	Com.	70	110	mA
			C-7	Ind.	70	125	mA
			C-10	Com.	60	90	mA
			C-10	Ind.	60	105	mA
			C-15	Com.	60	90	mA
			C-15	Ind.	60	105	mA
$IOS^{(1)}$	Output Short Circuit Current	$V_{OUT} = 0.5V$			-130	mA	
$V_{IL}$	Input Low Voltage		-0.5		0.8	V	
$V_{IH}$	Input High Voltage		2.0		$V_{CC} + 0.75$	V	
$V_{OL}$	Output Low Voltage	$V_{IN} = V_{IH} \text{ or } V_{IL},$ $V_{CC} = \text{Min}$	$I_{OL} = 24 \text{ mA}$	Com., Ind.		0.5	V
			$I_{OL} = 16 \text{ mA}$			0.5	V
$V_{OH}$	Output High Voltage	$V_{IN} = V_{IH} \text{ or } V_{IL},$ $V_{CC} = \text{Min}$	$I_{OH} = -4.0 \text{ mA}$		2.4		V

- Notes: 1. Not more than one output at a time should be shorted. Duration of short circuit test should not exceed 30 sec.  
 2. All values are at  $V_{CC}$  and  $T_A=25^\circ C$ .  
 3. Shaded area indicates preliminary data.

## AC Waveforms<sup>(1)</sup>

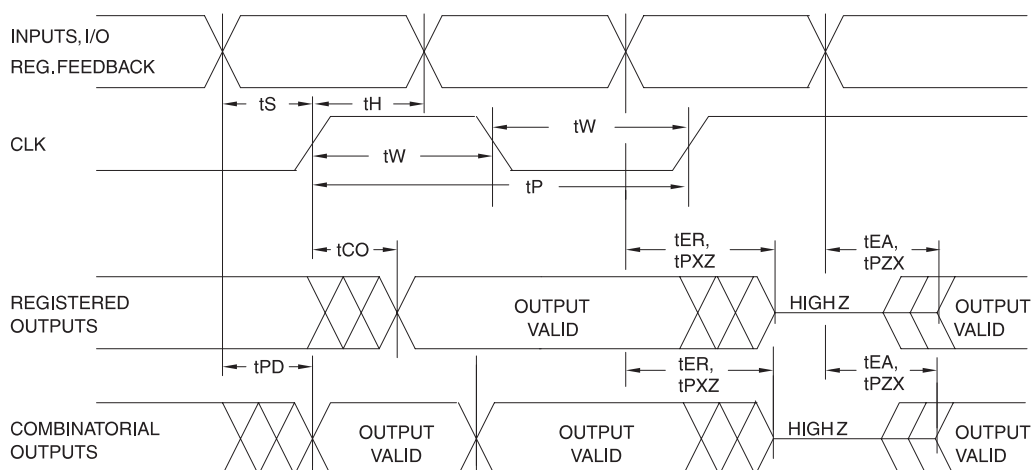

Note: 1. Timing measurement reference is 1.5V. Input AC driving levels are 0.0V and 3.0V, unless otherwise specified.

## ATF20V8C Family AC Characteristics<sup>(1)</sup>

Symbol	Parameter	C-5		C-7		C-10		C-15		Units		
		Min	Max	Min	Max	Min	Max	Min	Max			
$t_{PD}$	Input or Feedback to Non-registered Output	8 outputs switching		3	5	3	7.5	3	10	3	15	ns
		1 output switching					7				10	ns
$t_{CF}$	Clock to Feedback		3		3		6		8		ns	
$t_{CO}$	Clock to Output	2	4	2	5	2	7	2	10		ns	
$t_S$	Input or Feedback Setup Time	3		5		7.5		12			ns	
$t_H$	Hold Time	0		0		0		0			ns	
$t_P$	Clock Period	6		8		12		16			ns	
$t_W$	Clock Width	3		4		6		8			ns	
$f_{MAX}$	External Feedback $1/(t_S + t_{CO})$		143		100		68		45		MHz	
	Internal Feedback $1/(t_S + t_{CF})$		167		125		74		50		MHz	
	No Feedback $1/(t_P)$	7	167		125		83		62		MHz	
$t_{EA}$	Input to Output Enable – Product Term	3	6	3	9	3	10	3	15		ns	
$t_{ER}$	Input to Output Disable – Product Term	2	6	2	9	2	10	2	15		ns	
$t_{PZX}$	$\overline{OE}$ pin to Output Enable	2	5	2	6	2	10	2	15		ns	
$t_{PXZ}$	$\overline{OE}$ pin to Output Disable	1.5	5	1.5	6	1.5	10	1.5	15		ns	

Notes: 1. See ordering information for valid part numbers and speed grades.  
2. Shaded area indicates preliminary data.

# ATF20V8C Characteristic Curves

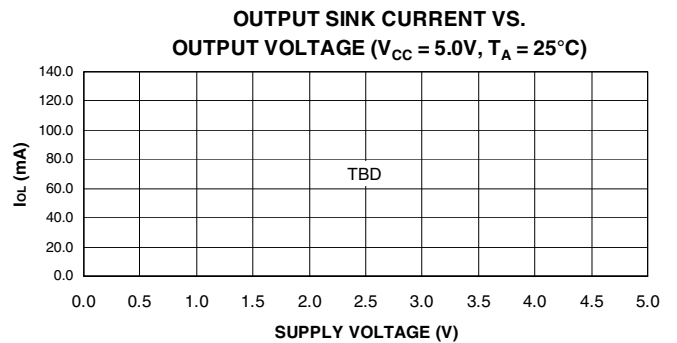
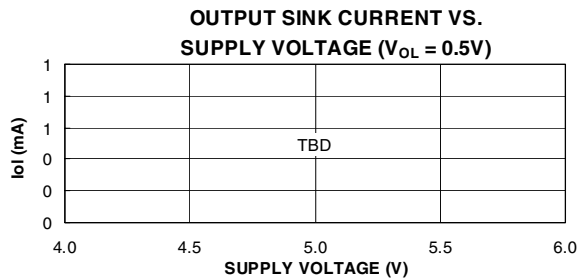
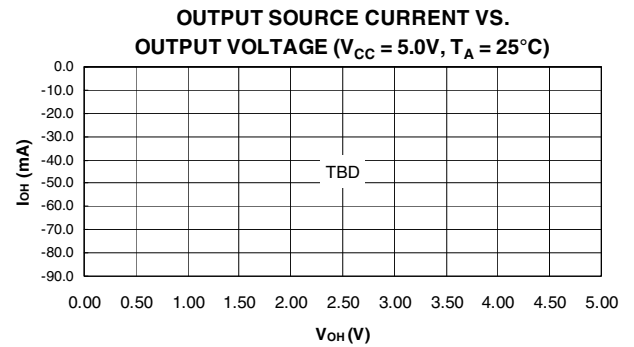
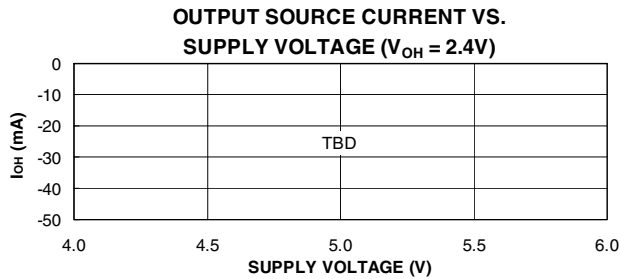
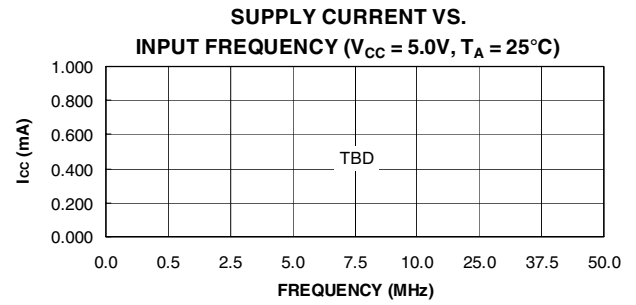
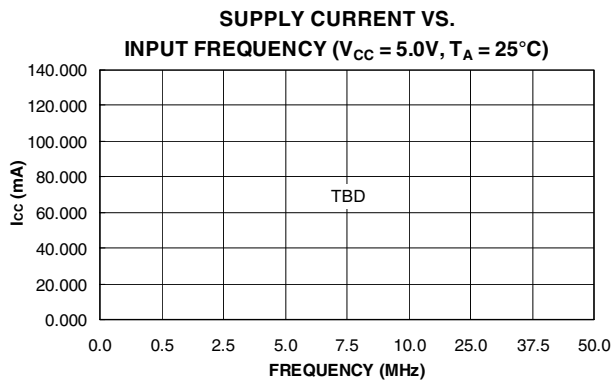
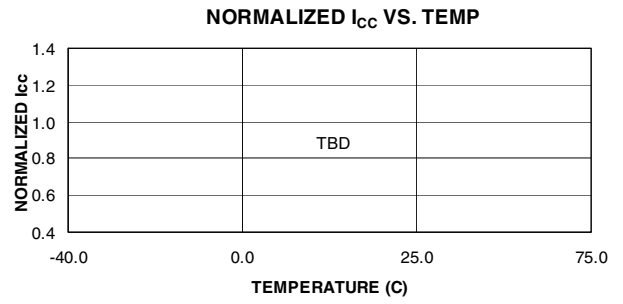
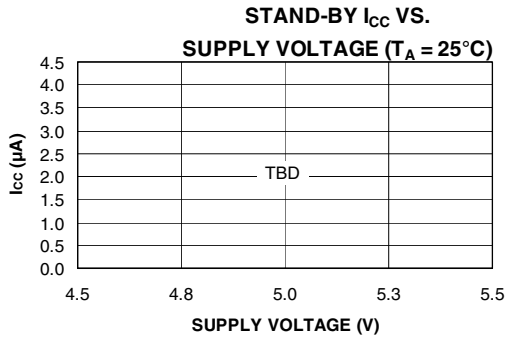

ATF20V8C Characteristic Curves (Continued)

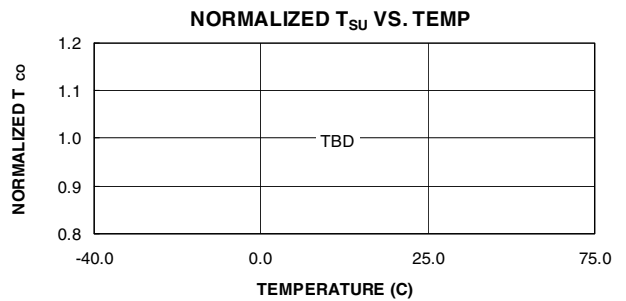
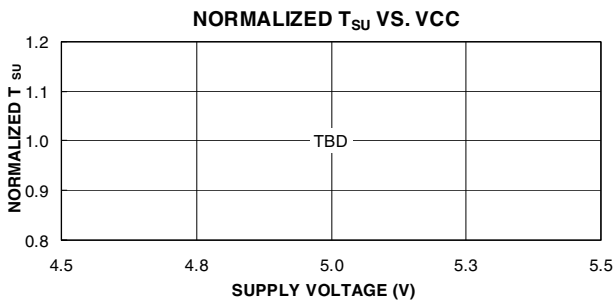
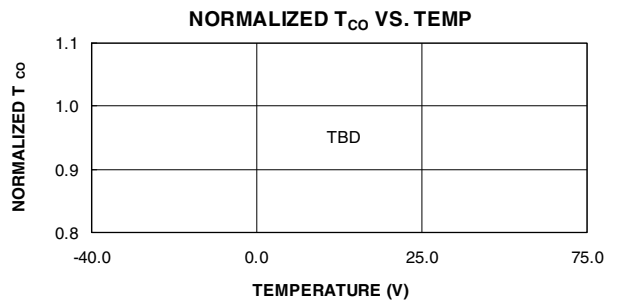
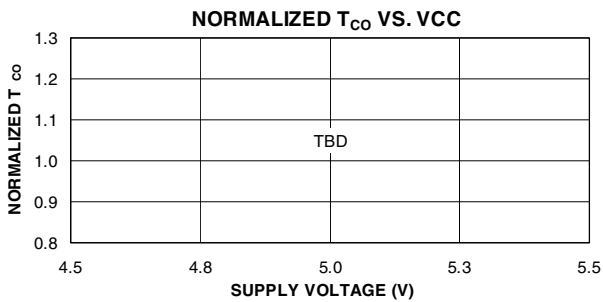
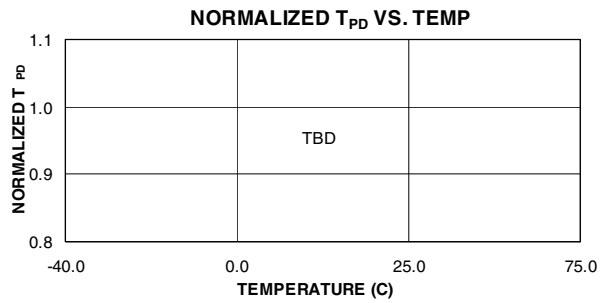
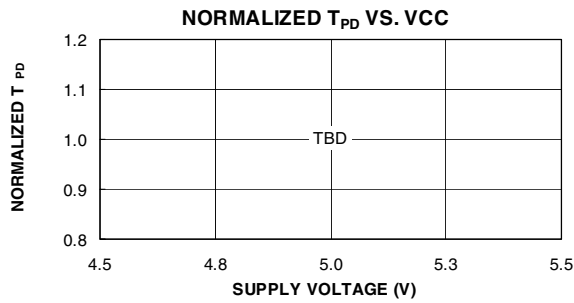
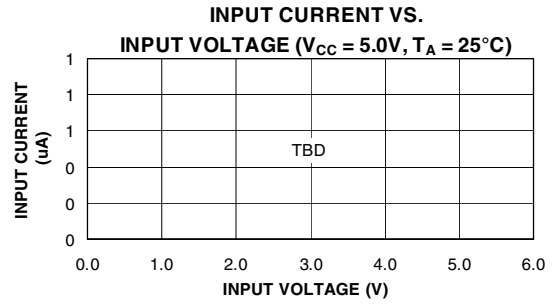
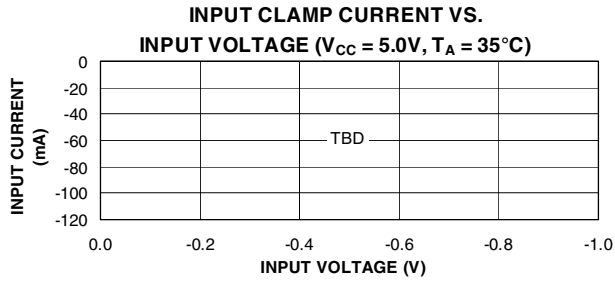



## ATF20V8C Characteristic Curves (Continued)

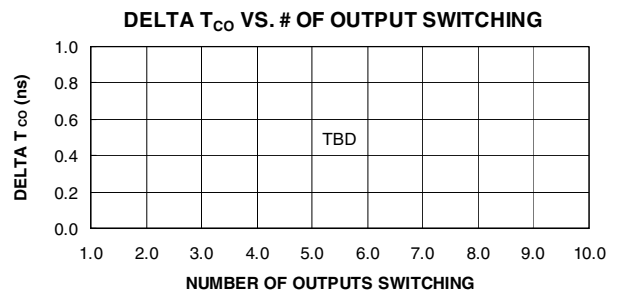
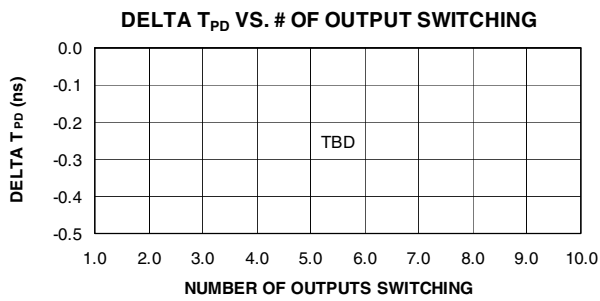
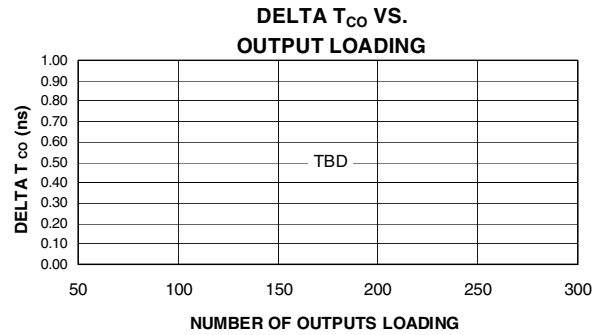
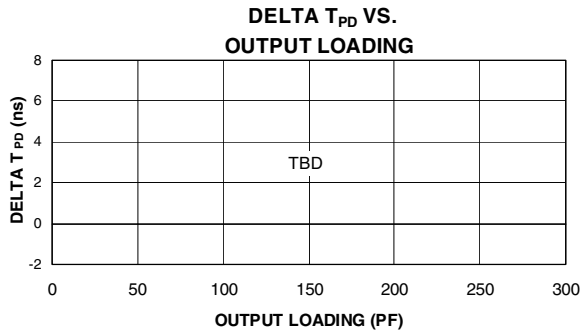



## ATF20V8CQ DC Characteristics

$V_{CC} = 5.0V$  and  $T_A = 25^\circ C$

Symbol	Parameter	Condition			Min	Typ	Max	Units
$I_{IL}$	Input or I/O Low Leakage Current	$0 \leq V_{IN} \leq V_{IL} \text{ (Max)}$				-35	-100	$\mu A$
$I_{IH}$	Input or I/O High Leakage Current	$3.5 \leq V_{IN} \leq V_{CC}$					10	$\mu A$
$I_{CC}$	Power Supply Current, Standby	$V_{CC} = \text{Max},$ $V_{IN} = \text{Max},$ Outputs Open	CQ-10, -15	Com.		10	25	$\mu A$
$I_{CC2}$	Clocked Power Supply Current	$V_{CC} = \text{Max},$ Outputs Open, $f = 15 \text{ MHz}$	CQ-10, 15	Com.		40	55	mA
$I_{OS}^{(1)}$	Output Short Circuit Current	$V_{OUT} = 0.5V$					-130	mA
$V_{IL}$	Input Low Voltage				-0.5		0.8	V
$V_{IH}$	Input High Voltage				2.0		$V_{CC} + 0.75$	V
$V_{OL}$	Output Low Voltage	$V_{IN} = V_{IH} \text{ or } V_{IL},$ $V_{CC} = \text{Min}$	$I_{OL} = 24 \text{ mA}$	Com., Ind.			0.5	V
			$I_{OL} = 16 \text{ mA}$				0.5	V
$V_{OH}$	Output High Voltage	$V_{IN} = V_{IH} \text{ or } V_{IL},$ $V_{CC} = \text{Min}$	$I_{OH} = -4.0 \text{ mA}$		2.4			V

- Notes: 1. Not more than one output at a time should be shorted. Duration of short circuit test should not exceed 30 sec.  
2. Shaded areas indicate preliminary data.



## ATF20V8CQ AC Characteristics<sup>(1)</sup>

Symbol	Parameter	CQ-10		Units	
		Min	Max		
$t_{PD}$	Input or Feedback to Non-registered Output	8 outputs switching	3	10	ns
		1 output switching			ns
$t_{CF}$	Clock to Feedback		6	ns	
$t_{CO}$	Clock to Output	2	7	ns	
$t_S$	Input or Feedback Setup Time	7.5		ns	
$t_H$	Hold Time	0		ns	
$t_P$	Clock Period	12		ns	
$t_W$	Clock Width	6		ns	
$f_{MAX}$	External Feedback $1/(t_S + t_{CO})$		68	MHz	
	Internal Feedback $1/(t_S + t_{CF})$		74	MHz	
	No Feedback $1/(t_P)$		83	MHz	
$t_{EA}$	Input to Output Enable – Product Term	3	10	ns	
$t_{ER}$	Input to Output Disable – Product Term	2	10	ns	
$t_{PZX}$	$\overline{OE}$ pin to Output Enable	2	10	ns	
$t_{PXZ}$	$\overline{OE}$ pin to Output Disable	1.5	10	ns	

- Notes:
1. See ordering information for valid part numbers and speed grades.
  2. All values are at  $V_{CC}=5V$  and  $T_A=25^\circ C$ .
  3. Shaded areas indicate preliminary data.

## ATF20V8CQ Characteristic Curves

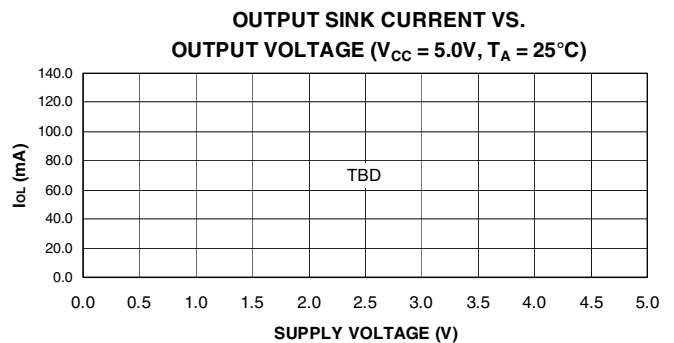
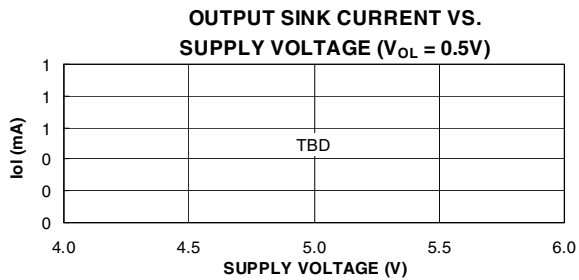
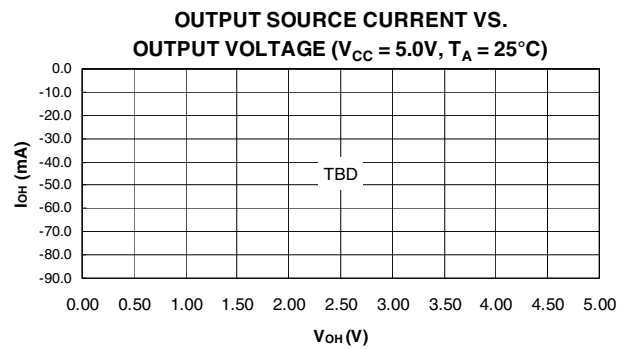
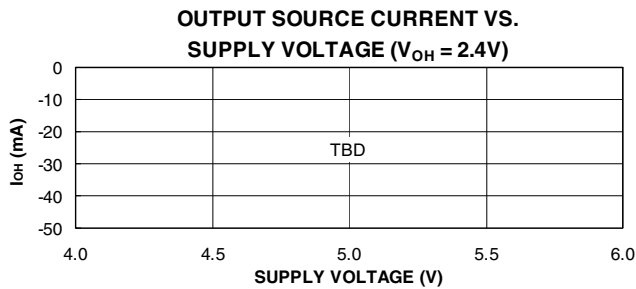
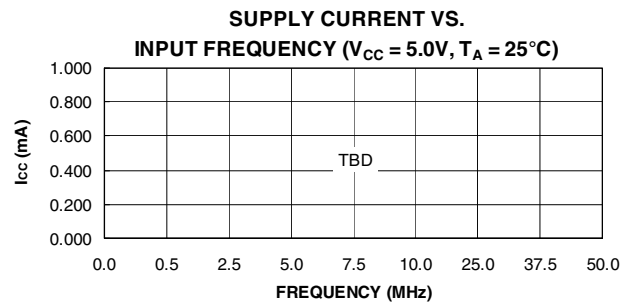
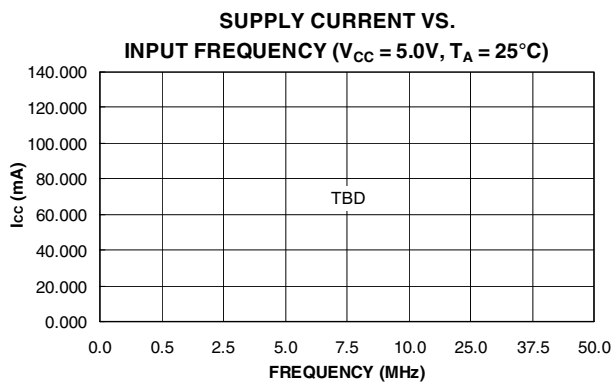
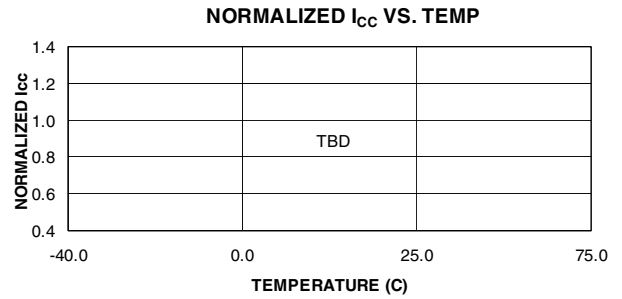
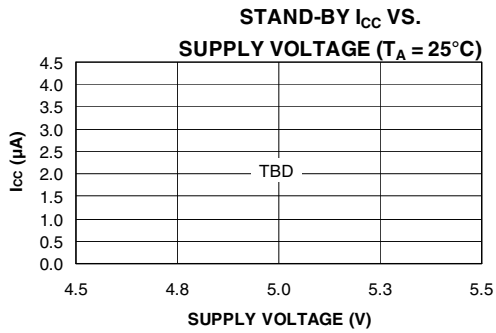

# ATF20V8CQ Characteristic Curves (Continued)

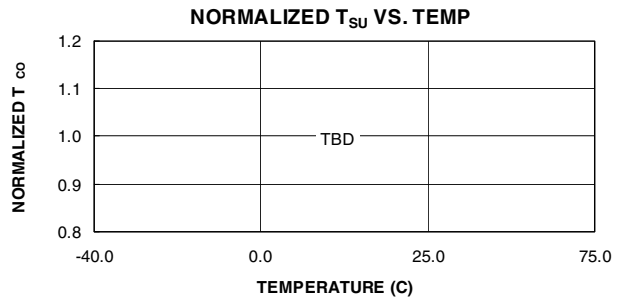
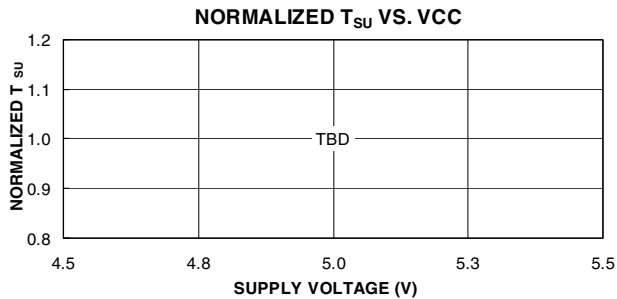
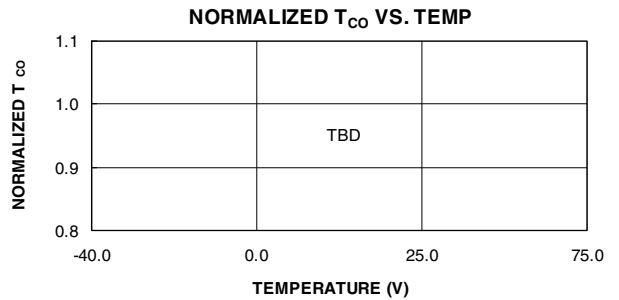
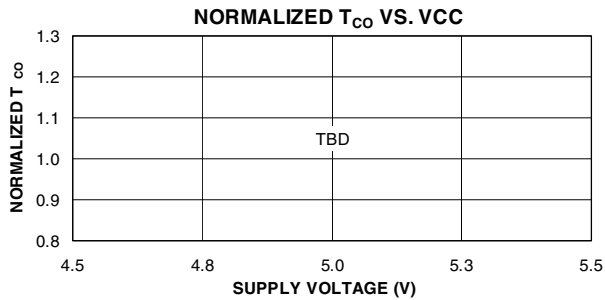
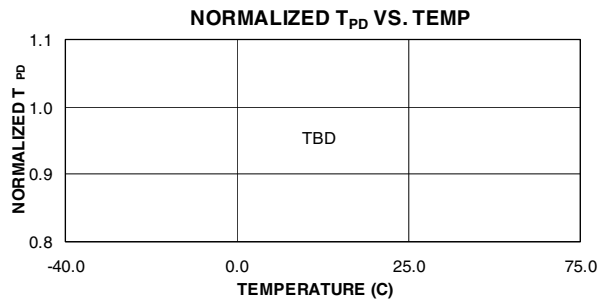
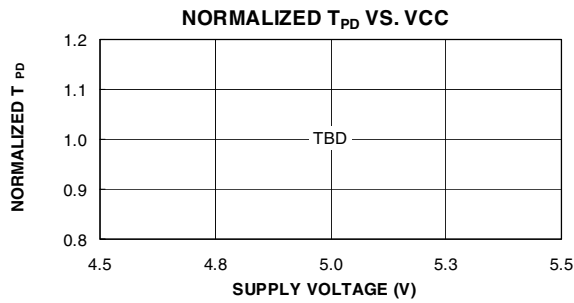
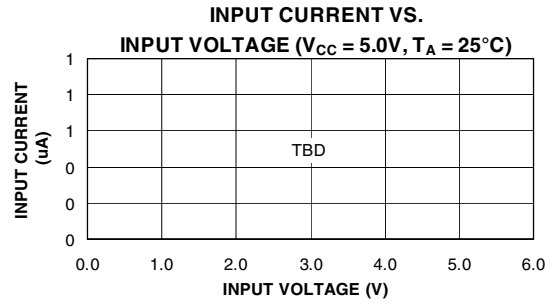
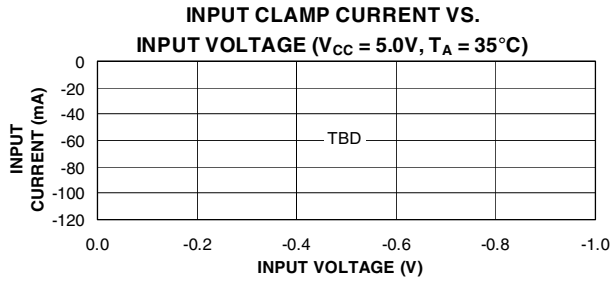

ATF20V8CQ Characteristic Curves (Continued)

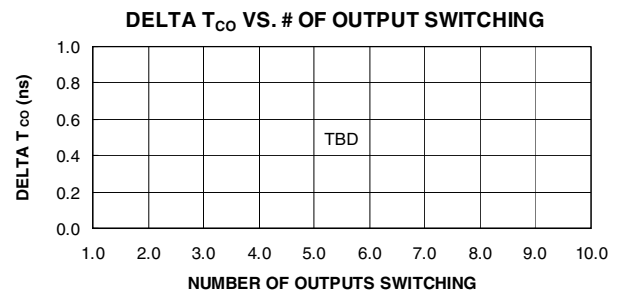
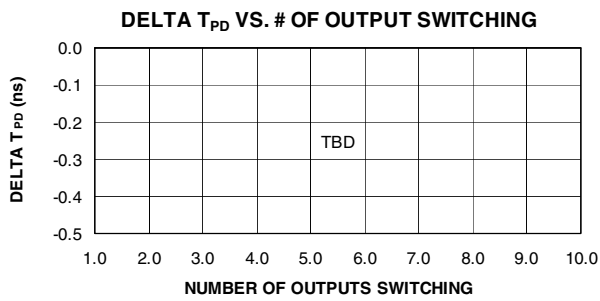
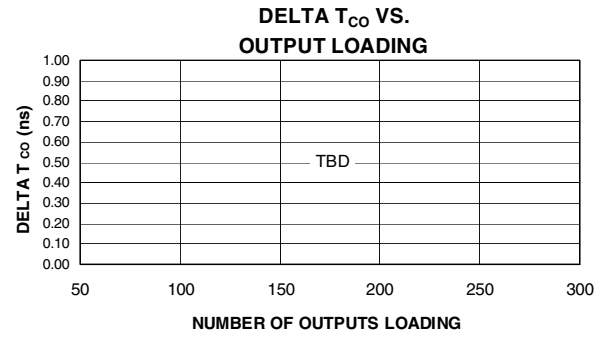
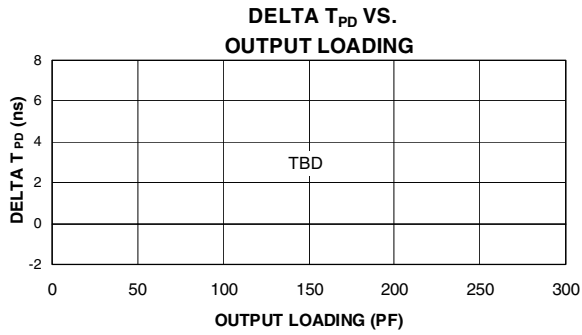

## ATF20V8CQZ DC Characteristics

$V_{CC} = 5.0V$  and  $T_A = 25^\circ C$

Symbol	Parameter	Condition		Min	Typ	Max	Units
$I_{IL}$	Input or I/O Low Leakage Current	$0 \leq V_{IN} \leq V_{IL} \text{ (Max)}$			-35	-100	$\mu A$
$I_{IH}$	Input or I/O High Leakage Current	$3.5 \leq V_{IN} \leq V_{CC}$				10	$\mu A$
$I_{CC}$	Power Supply Current, Standby	$V_{CC} = \text{Max},$ $V_{IN} = \text{Max},$ Outputs Open	CQZ-15	Com.	10	25	$\mu A$
				Ind.	10	50	$\mu A$
$I_{CC2}$	Clocked Power Supply Current	$V_{CC} = \text{Max},$ Outputs Open, $f = 15 \text{ MHz}$	CQZ-15	Com.	20	35	mA
				Ind.	20	40	mA
$I_{OS}^{(1)}$	Output Short Circuit Current	$V_{OUT} = 0.5V$				-130	mA
$V_{IL}$	Input Low Voltage			-0.5		0.8	V
$V_{IH}$	Input High Voltage			2.0		$V_{CC} + 0.75$	V
$V_{OL}$	Output Low Voltage	$V_{IN} = V_{IH} \text{ or } V_{IL},$ $V_{CC} = \text{Min}$	$I_{OL} = 24 \text{ mA}$ $I_{OL} = 16 \text{ mA}$	Com., Ind.		0.5	V
						0.5	V
$V_{OH}$	Output High Voltage	$V_{IN} = V_{IH} \text{ or } V_{IL},$ $V_{CC} = \text{Min}$	$I_{OH} = -4.0 \text{ mA}$	2.4			V

- Notes:
1. Not more than one output at a time should be shorted. Duration of short circuit test should not exceed 30 sec.
  2. All values are at  $V_{CC}=5V$  and  $T_A=25^\circ C$ .
  3. Shaded areas indicate preliminary data.

## ATF20V8CQZ AC Characteristics<sup>(1)</sup>

Symbol	Parameter	CQZ-15		Units	
		Min	Max		
$t_{PD}$	Input or Feedback to Non-registered Output	8 outputs switching	3	15	ns
		1 output switching		10	ns
$t_{CF}$	Clock to Feedback		8	ns	
$t_{CO}$	Clock to Output	2	10	ns	
$t_S$	Input or Feedback Setup Time	12		ns	
$t_H$	Hold Time	0		ns	
$t_P$	Clock Period	16		ns	
$t_W$	Clock Width	8		ns	
$f_{MAX}$	External Feedback $1/(t_S + t_{CO})$		45	MHz	
	Internal Feedback $1/(t_S + t_{CF})$		50	MHz	
	No Feedback $1/(t_P)$		62	MHz	
$t_{EA}$	Input to Output Enable – Product Term	3	15	ns	
$t_{ER}$	Input to Output Disable – Product Term	2	15	ns	
$t_{PZX}$	$\overline{OE}$ pin to Output Enable	2	15	ns	
$t_{PXZ}$	$\overline{OE}$ pin to Output Disable	1.5	15	ns	

- Notes: 1. See ordering information for valid part numbers and speed grades.  
 2. Shaded areas indicate preliminary data.

# ATF20V8CQZ Characteristic Curves

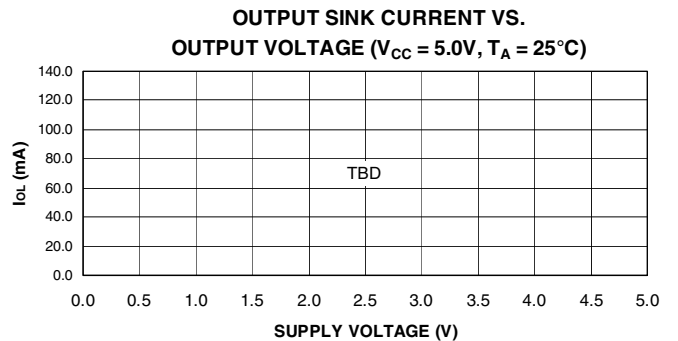
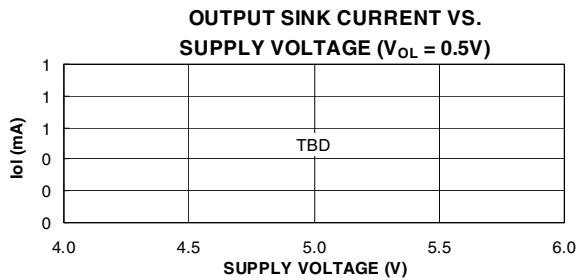
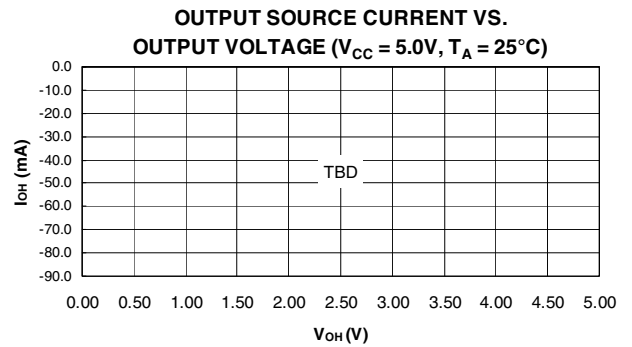
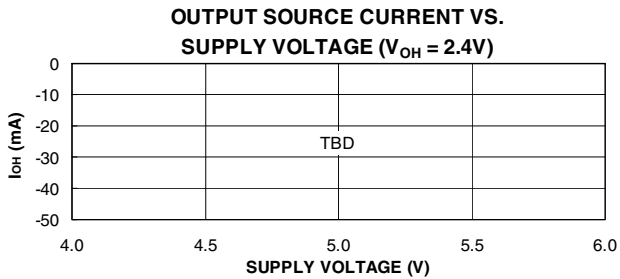
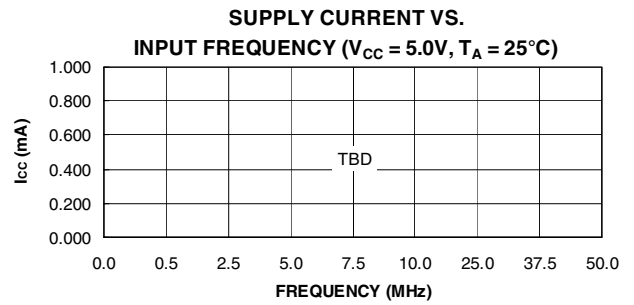
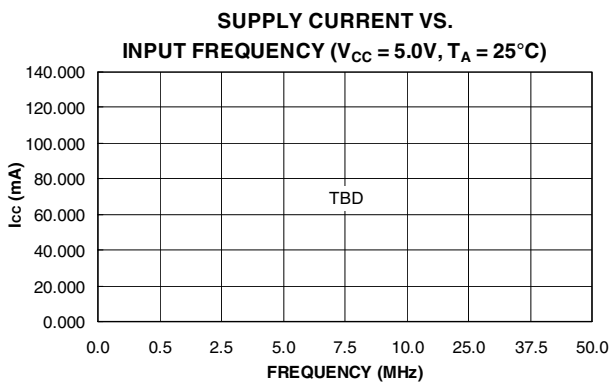
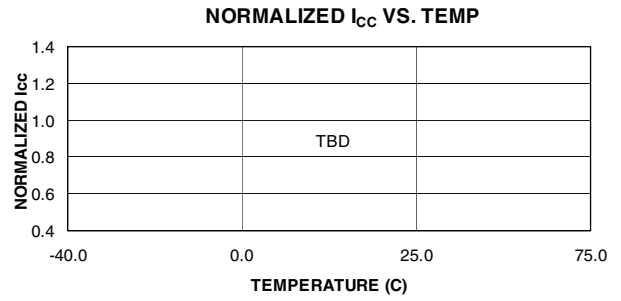
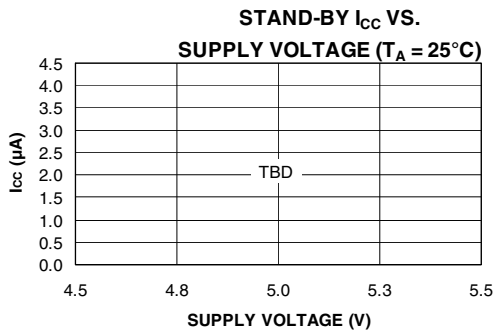



ATF20V8CQZ-15 Characteristic Curves (Continued)

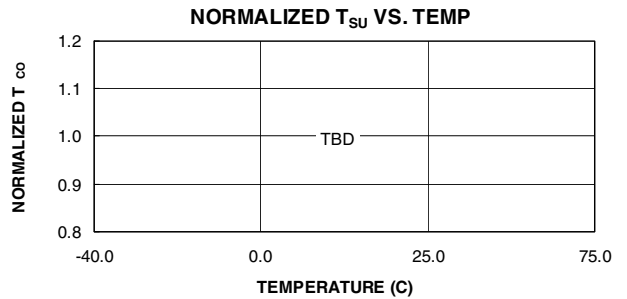
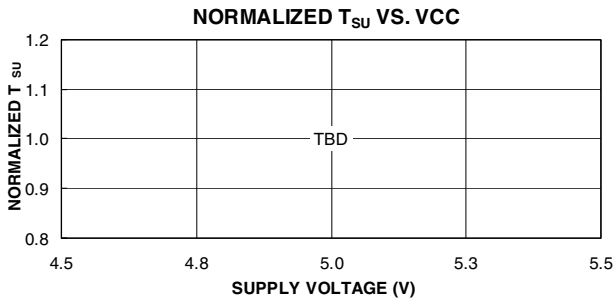
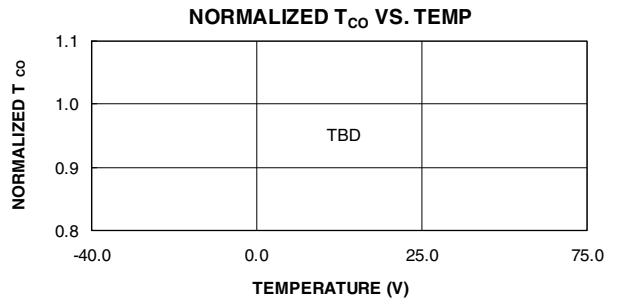
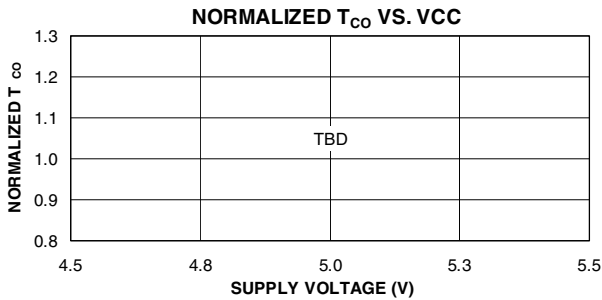
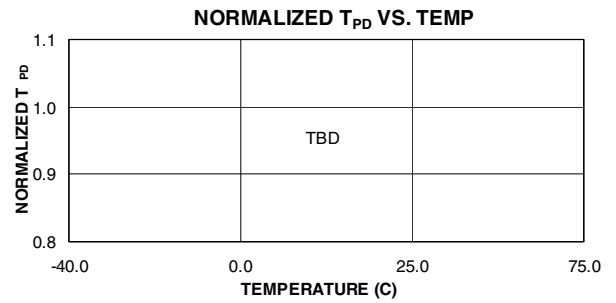
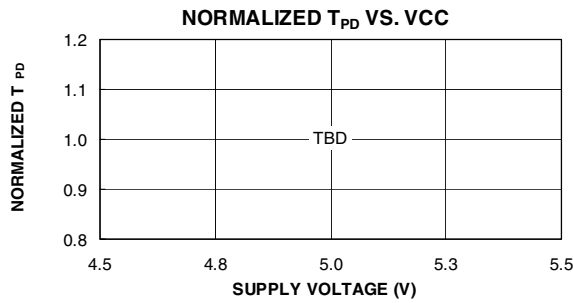
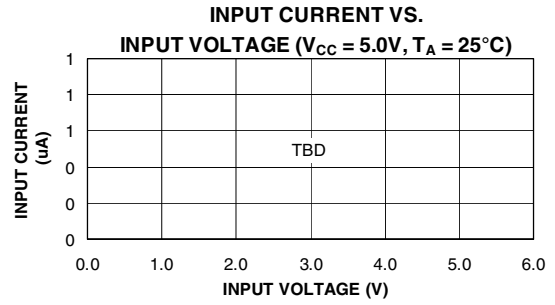
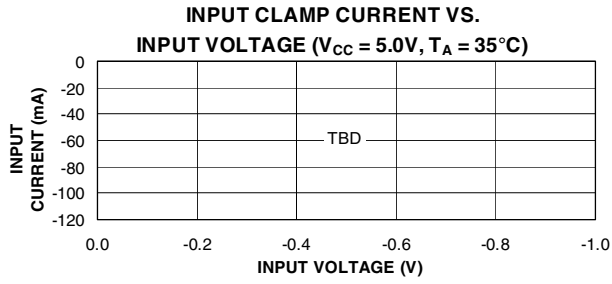



## ATF20V8CQZ-15 Characteristic Curves (Continued)

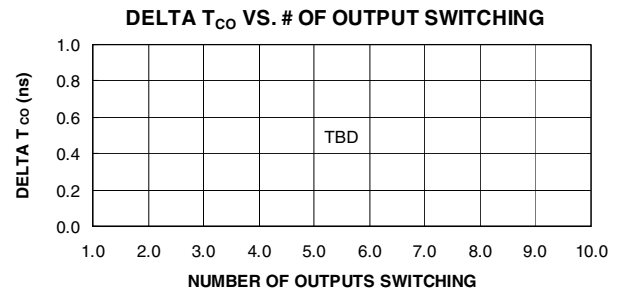
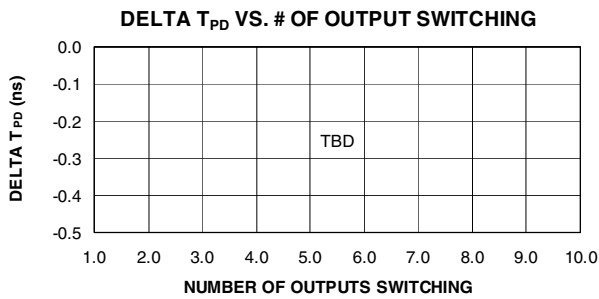
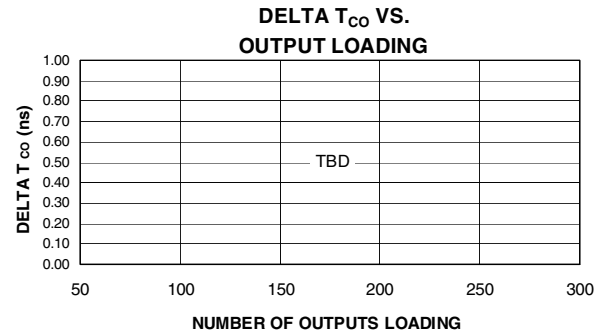
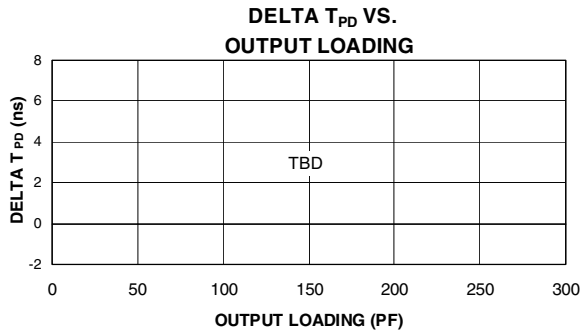

## ATF20V8C Family Ordering Information

$t_{PD}$ (ns)	$t_S$ (ns)	$t_{CO}$ (ns)	Ordering Code	Package	Operation Range
5	3	4	ATF20V8C-5JC	28J	Commercial (0°C to 70°C)
7.5	3.5	4.5	ATF20V8C-7JC ATF20V8C-7PC ATF20V8C-7SC ATF20V8C-7XC	28J 24P3 24S 24X	Commercial (0°C to 70°C)
			ATF20V8C-7JI ATF20V8C-7PI ATF20V8C-7SI ATF20V8C-7XI	28J 24P3 24S 24X	Industrial (-40°C to 85°C)
10	4.5	6.5	ATF20V8C-10JC ATF20V8C-10PC ATF20V8C-10SC ATF20V8C-10XC	28J 24P3 24S 24X	Commercial (0°C to 70°C)
			ATF20V8C-10JI ATF20V8C-10PI ATF20V8C-10SI ATF20V8C-10XI	28J 24P3 24S 24X	Industrial (-40°C to 85°C)
15	10	8	ATF20V8C-15JC ATF20V8C-15PC ATF20V8C-15SC ATF20V8C-15XC	28J 24P3 24S 24X	Commercial (0°C to 70°C)
			ATF20V8C-15JI ATF20V8C-15PI ATF20V8C-15SI ATF20V8C-15XI	28J 24P3 24S 24X	Industrial (-40°C to 85°C)
10	7.5	7	ATF20V8CQ-10JC ATF20V8CQ-10PC ATF20V8CQ-10SC ATF20V8CQ-10XC	28J 24P3 24S 24X	Commercial (0°C to 70°C)
			ATF20V8CQ-10JI ATF20V8CQ-10PI ATF20V8CQ-10SI ATF20V8CQ-10XI	28J 24P3 24S 24X	Industrial (-40°C to 85°C)
15	10	8	ATF20V8CQZ-15JC ATF20V8CQZ-15PC ATF20V8CQZ-15SC ATF20V8CQZ-15XC	28J 24P3 24S 24X	Commercial (0°C to 70°C)
			ATF20V8CQZ-15JI ATF20V8CQZ-15PI ATF20V8CQZ-15SI ATF20V8CQZ-15XI	28J 24P3 24S 24X	Industrial (-40°C to 85°C)

Note: 1. Shaded areas indicate preliminary data.



## Using “C” Product for Industrial

To use commercial product for industrial temperature ranges, down-grade one speed grade from the “I” to the “C” device (7 ns “C” = 10 ns “I”) and de-rate power by 30%.

Package Type	
<b>28J</b>	28-lead, Plastic J-leaded Chip Carrier (PLCC)
<b>24P3</b>	24-lead, 0.300" Wide, Plastic Dual Inline Package (PDIP)
<b>24S</b>	24-lead, 0.300" Wide, Plastic Gull Wing Small Outline (SOIC)
<b>24X</b>	24-lead, 4.4 mm Wide, Plastic Thin Shrink Small Outline (TSSOP)

## Packaging Information

**28J**, 28-lead, Plastic J-leaded Chip Carrier (PLCC)  
 Dimensions in Inches and (Millimeters)  
 JEDEC STANDARD MS-018 AB

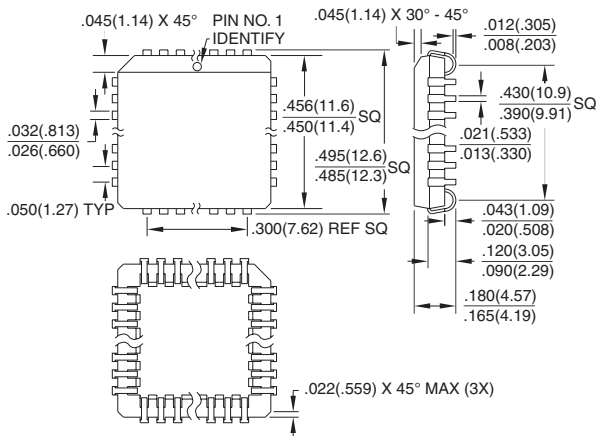

**24P3**, 24-lead, 0.300" Wide, Plastic Dual Inline Package (PDIP)  
 Dimensions in Inches and (Millimeters)  
 JEDEC STANDARD MS-001 AF

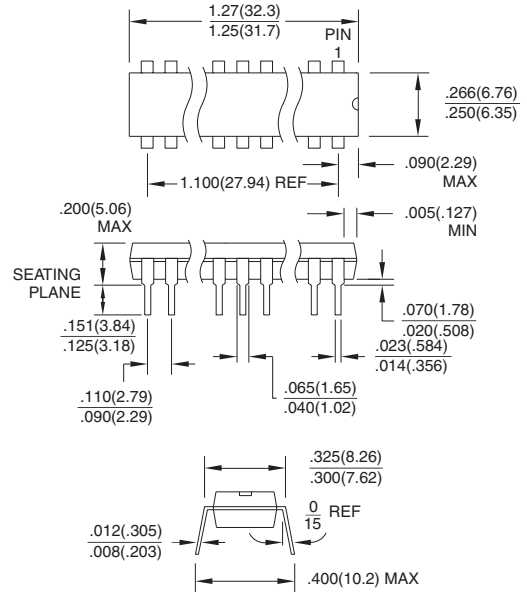

**24S**, 24-lead, 0.300" Wide, Plastic Gull Wing Small Outline (SOIC)  
 Dimensions in Inches and (Millimeters)

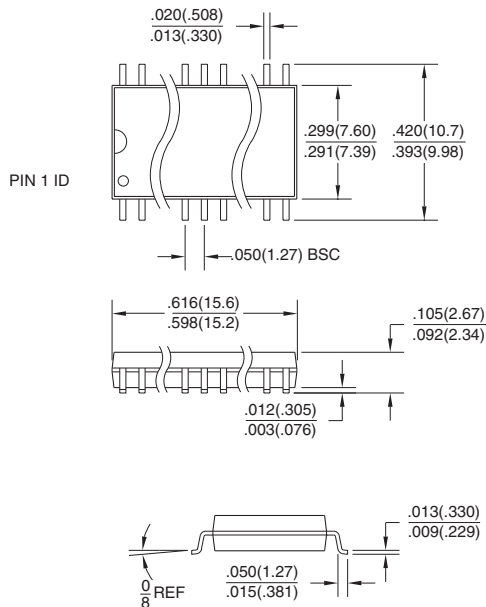

**24X**, 24-lead, 4.4 mm Wide, Plastic Thin Shrink Small Outline (TSSOP)  
 Dimensions in Millimeters and (Inches)

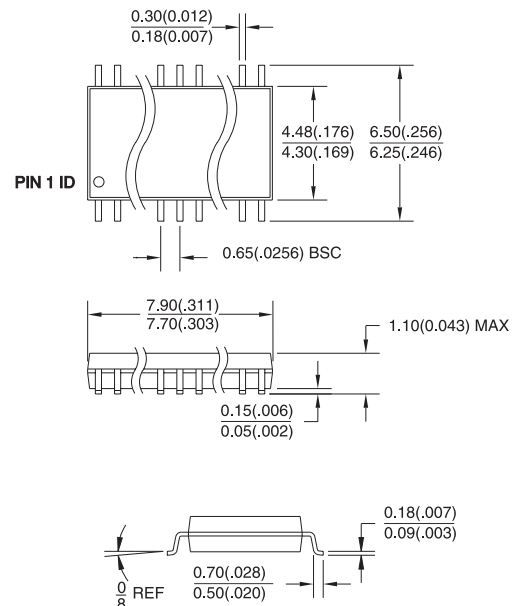



## Atmel Headquarters

### *Corporate Headquarters*

2325 Orchard Parkway  
San Jose, CA 95131  
TEL (408) 441-0311  
FAX (408) 487-2600

### *Europe*

Atmel SarL  
Route des Arsenaux 41  
Casa Postale 80  
CH-1705 Fribourg  
Switzerland  
TEL (41) 26-426-5555  
FAX (41) 26-426-5500

### *Asia*

Atmel Asia, Ltd.  
Room 1219  
Chinachem Golden Plaza  
77 Mody Road Tsimhatsui  
East Kowloon  
Hong Kong  
TEL (852) 2721-9778  
FAX (852) 2722-1369

### *Japan*

Atmel Japan K.K.  
9F, Tonetsu Shinkawa Bldg.  
1-24-8 Shinkawa  
Chuo-ku, Tokyo 104-0033  
Japan  
TEL (81) 3-3523-3551  
FAX (81) 3-3523-7581

## Atmel Operations

### *Atmel Colorado Springs*

1150 E. Cheyenne Mtn. Blvd.  
Colorado Springs, CO 80906  
TEL (719) 576-3300  
FAX (719) 540-1759

### *Atmel Rousset*

Zone Industrielle  
13106 Rousset Cedex  
France  
TEL (33) 4-4253-6000  
FAX (33) 4-4253-6001

### *Atmel Smart Card ICs*

Scottish Enterprise Technology Park  
East Kilbride, Scotland G75 0QR  
TEL (44) 1355-357-000  
FAX (44) 1355-242-743

### *Atmel Grenoble*

Avenue de Rochepleine  
BP 123  
38521 Saint-Egreve Cedex  
France  
TEL (33) 4-7658-3000  
FAX (33) 4-7658-3480

---

### *Fax-on-Demand*

North America:  
1-(800) 292-8635  
International:  
1-(408) 441-0732

### *e-mail*

literature@atmel.com

### *Web Site*

<http://www.atmel.com>

### *BBS*

1-(408) 436-4309

### © Atmel Corporation 2001.

Atmel Corporation makes no warranty for the use of its products, other than those expressly contained in the Company's standard warranty which is detailed in Atmel's Terms and Conditions located on the Company's web site. The Company assumes no responsibility for any errors which may appear in this document, reserves the right to change devices or specifications detailed herein at any time without notice, and does not make any commitment to update the information contained herein. No licenses to patents or other intellectual property of Atmel are granted by the Company in connection with the sale of Atmel products, expressly or by implication. Atmel's products are not authorized for use as critical components in life support devices or systems.

Marks bearing ® and/or ™ are registered trademarks and trademarks of Atmel Corporation.

Terms and product names in this document may be trademarks of others.



Printed on recycled paper.

0408H-04/01/xM